



INTELLIGENT GLASS®

USER GUIDE

SWITCHABLE FILM

| | | | |
|---|---|--|----|
| Shipping | 3 | Electrical Installation Guidelines | 11 |
| Receiving. | 3 | Switchable Film Specifications | 12 |
| Storage. | 4 | Transformer Specifications | 13 |
| Handling | 4 | Wiring Diagrams | 14 |
| General Installation Guidelines | 5 | Cleaning & Aftercare | 15 |
| Film Installation | 6 | Warranty | 15 |

SWITCH ON TO INTELLIGENT GLASS

Established in 2004, Intelligent Glass are the UK’s longest serving switchable technology provider. Part of the Pro Display Group, our patented manufacturing processes allow us to offer the widest range of switchable products on the market with industry leading clarity levels. This guide covers the installation steps, cleaning and aftercare and technical specifications for our Switchable Film.

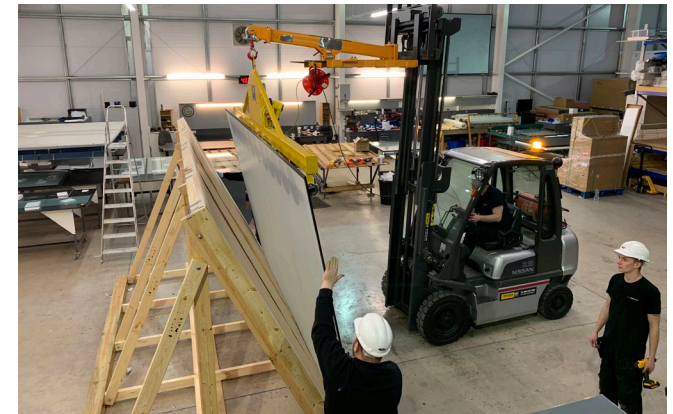

SHIPPING

A full packaging and shipping service is available for UK and worldwide export.

All packaging is robust and designed to provide protection during transit. It is the responsibility of the recipient to offload deliveries, unless otherwise agreed.

Please notify us prior to dispatch if the delivery address is restricted or this could result in additional shipping charges.

For UK shipments, we offer next-day or dedicated same-day deliveries whereas for overseas customers we can ship via Road, Air or Sea depending on your preference. Please note, overseas customers are responsible for customs and clearance.

All consignments are insured to the full value of the goods. A quotation for packaging, shipping and insurance will be provided prior to dispatch.



RECEIVING

Before accepting the shipment from the carrier, the packaging should be inspected for shortages or damage.

If shortages or damage is found, please could you make a note of this on the shippers paperwork and notify us as soon as possible within 24 hours in order for us to make an insurance claim with the shipper.



STORAGE

If the film is not being installed immediately, we recommend that it is stored in the original packaging in a dry, cool area away from direct sunlight.

HANDLING

- Never fold, bend, or curve Switchable Film.
- Always keep the film flat and straight, as shown in the images below.
- Do not remove the protective liners until you are ready to install the film.
- When handling the film, take particular care with the edges to avoid delaminating the film layers.



GENERAL INSTALLATION GUIDELINES

We recommend that each piece of the film should be inspected prior to installation. Do not attempt to install products which you consider to be incorrectly sized or damaged in any way. Any attempt to install a deficient product will signify acceptance of its suitability and cannot be replaced.

Switchable Film adheres to glass using an electrostatic self-adhesive layer and is a dry apply product. Please do not use water under any circumstances as this will damage the adhesive layer.

We recommend that the film dimensions are cut 3mm smaller (width and height) than the visual area of the glass to ensure a smooth installation. In the event that the film needs trimming on site, please contact us for guidance.

We recommend that Switchable Film is installed in a clean environment where no other building works are ongoing. In the event of dust on the adhesive layer, we would recommend carefully peeling the film back, cleaning the glass with IPA wipes then wrapping masking tape around your finger with the adhesive side facing out and dabbing the adhesive layer until the dust is removed.

The busbar or electrical connections should never make contact with any metal frames or trims. Switchable Film should never be installed in situations where it may be subjected to loading, pressure or mechanical stress. For example, clamped between metal or plastic fittings, door furniture, and framework or subjected to any other form of concentrated mechanical loads or stress.

We recommend that the electrical connections are positioned along the top edge of the panel. When film is installed in environments where it may be subject to dampness or humidity, each edge must be completely sealed to be impervious to moisture ingress, and particular attention must be paid to sealing the bus bar edge.

We only recommend the use of Intelligent Glass specialist sealant for use with any of our products, this can be supplied by us on request. We only recommend using our Switchable Laminate and Switchable Double-Glazed products for Bathroom applications and it is important a qualified professional installs these products within the appropriate zone within the Bathroom.

Customer specified holes and cut-outs produced during the manufacturing process may cause the edge of the film to whiten slightly, and as such will require coverage by a trim or fitting. Care should be taken when installing door fixtures and fittings and metal parts should never have direct contact with the surface of the film. To avoid the risk of mechanical threaded fixings becoming loose and making contact with the film over time, the use of a high-quality thread adhesive in line with the manufacturer's instructions should also be considered.

When joining multiple pieces of Switchable Film on the same panel of glass, we recommend leaving a 2mm gap to prevent the film pieces from coming into contact with each other.

It is also recommended that the bus bar tags of films being applied side by side are positioned with the same polarity adjoining each other (e.g. positive and positive or negative and negative).



FILM INSTALLATION

STEP 1: EQUIPMENT REQUIRED

- Glass cleaner
- Felt edged squeegee
- Powder free nitrile gloves
- Cleaning cloth
- IPA wipes
- Electrical cable
- Cable strippers
- Soldering iron (Pre-soldered cables available on request)
- Lead free solder
- Specialist sealant
- Non-metallic cover trims

STEP 2: GLASS PREPARATION

Spray the glass with a liquid glass cleaner and clean with a soft lint free cloth. Repeat this process until completely clean and dust free.

Using a lint free cloth, clean the glass surface meticulously with IPA (isopropyl alcohol) and leave to evaporate.

Recommendation:

Please ensure there are no irregularities around the frame (silicone etc.) which could impact the film from adhering flat to the glass surface.

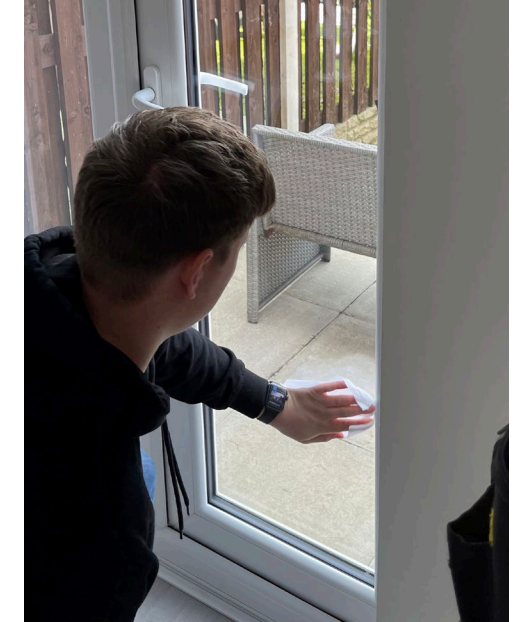

STEP 3: PREPARATION OF THE FILM

Place the film in a clean, flat area (preferably a table which supports the entire film), ensuring the electrostatic adhesive layer is facing up.

Wipe down the protective liner of the Switchable Film to remove any dust.

Before commencing installation, ensure the film fits correctly within the visual glass area by carefully positioning it against the surface whilst checking for the required clearances.



STEP 4: PREPARATION OF THE FILM FOR APPLICATION

Using the edge tab on the label, remove the first 100mm of the protective liner applied to the self-adhesive layer of the Switchable Film completely along the bus bar edge.

Recommendation:

We recommend wearing nitrile gloves while installing the film to avoid fingerprints on the adhesive layer.



STEP 5: INITIAL POSITIONING OF THE FILM ON GLASS

Accurately align the edge of the Switchable Film with the top edge of the glass. When in position, gently run a finger along the film just below the edge to achieve an initial adhesion of the film to the glass, with 100mm of the self-adhesive layer already exposed.

Recommendation:

A clear adhesive tape may be used along the bus bar edge to prevent this from lifting. An additional insulation tape can also be used over the bus bar and wiring to provide protection to the electrical contacts.

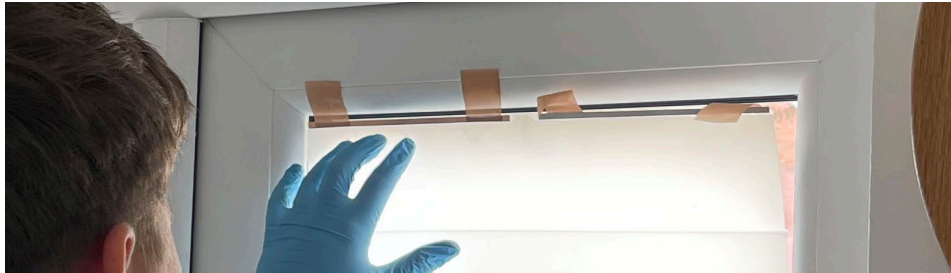

STEP 6: APPLICATION OF THE FILM TO GLASS

Whilst gently supporting the film at the edges, and at a shallow angle to the glass surface, gently pull away the liner from the adhesive surface and allow the film to adhere to the glass under its own weight.

Use the squeegee to work out any air pockets to the sides or the working edge of the film.

To work out any air pockets between the film and the glass, slowly and carefully ease the film back from the glass and allow the film to re-adhere to the glass using its own weight, whilst working with the squeegee to remove the trapped air.

Continue this process to the bottom of the film until it is fully installed on the surface of the glass.



STEP 7: FINALISING APPLICATION

Using the felt-edge squeegee, gently work out any remaining small bubbles to the edges of the film, ensuring that the edges have good contact with the glass.

If you need to lift the film from the glass after it's been fully applied, we recommend using the tip of a fine blade (e.g. scalpel or craft knife) to ease one of the corners away from the glass, taking care not to damage or delaminate the film layers. Never use a thumb or fingernail as this could cause delamination of the film layers.

Recommendation:

In the event of dust on the adhesive layer, we would recommend carefully peeling the film back, cleaning the glass with IPA wipes then wrapping masking tape around your finger with the adhesive side facing out and dabbing the adhesive layer until the dust is removed.



STEP 8: WIRING THE BUSBARS

Once the installation of the film is satisfactorily completed, electrical installation can commence. Begin by carefully soldering the electrical cables to the copper mesh tags. NOTE: there are two tags on the left side of the film and two tags on the right side. Only one tag from each side is to be used. Solder a cable to one of the mesh tags on the left (positive) and one of the mesh tags on the right (negative). The two remaining tags are spare. Pre-soldered cables are also available on request for an additional charge.

It is recommended that the film is tested for correct operation at this stage by temporarily connecting the cables to the transformer and switch to ensure that the film is switching from frosted to clear. Once testing is complete, neatly fold the spare tags back to the film, this can be used if accidental damage occurs to the original connections.

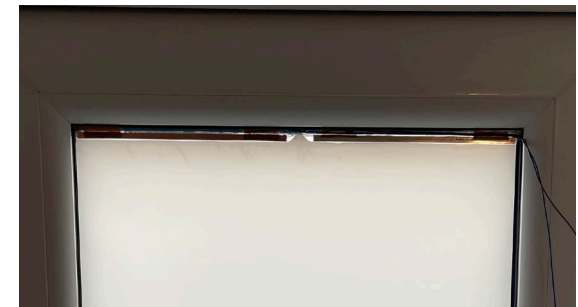
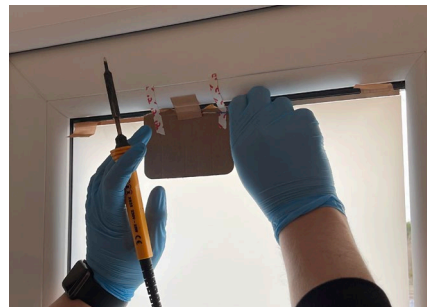
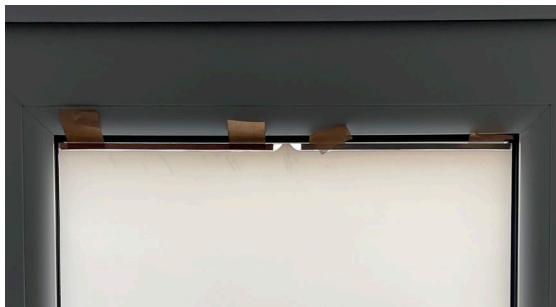

STEP 9: REMOVAL OF OUTER PROTECTIVE LINER

Locate the top edge of the outer protective liner, (approximately 10-15mm below the busbar). Starting in one corner, begin to ease the protective liner diagonally from the face of the Switchable Film, until the liner is removed across its entire width.

Slowly and smoothly, in a downward motion, pull the liner from the surface of the Switchable Film.



STEP 10: PROTECTIVE TRIM

Adhere a strip of narrow clear double sided adhesive tape along the top of the film over the busbar to tack the cables in place.

The bus bars and cables should be securely covered with a suitable non-conductive trim and sealed with Intelligent Glass specialist sealant to prevent the ingress of moisture onto the electrical connections.

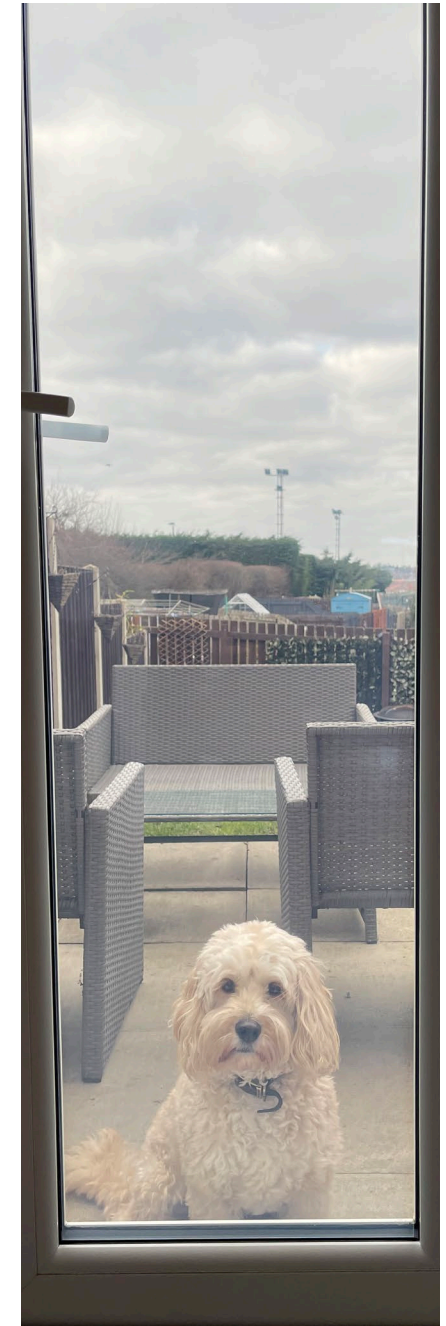
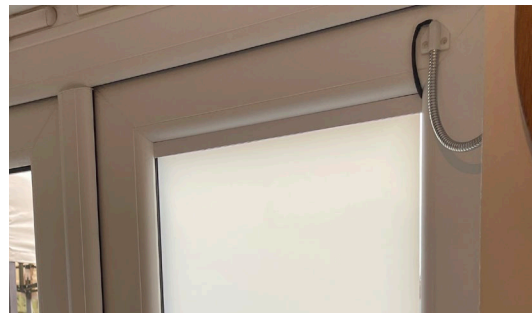

ELECTRICAL INSTALLATION GUIDELINES

All installations should meet the requirements of local regulations and guidelines and be carried out by a qualified electrician.

Any metal framework close to or adjoining the wiring of the panel must be earthed. Switchable Film should never be installed in direct contact with a metal frame.

If in doubt, consult a qualified electrician prior to commencing any installation work. Any metal frames must be fully sealed to prevent the ingress of moisture or water.

Switchable Glass / film products operate at 48-65v AC. The correct voltage must be applied to the product using Pro Display approved thermally protecting isolated transformers. Increased power over the recommend voltage can cause irreversible damage and will not be covered under warranty.

Any damages occurred with the use of a 3rd party transformer are not covered by the warranty.

Multiple Switchable Film panels can be connected in parallel to a single transformer.

An RCD with an MCB, or an RCBO should be used along with a fused spur at the connection point to provide local isolation.

Selecting the right one should be done in accordance with BS 7671: Requirements for Electrical Installations and will ensure that the device will not give unwanted tripping due to high inrush currents generated by the transformer(s).

The manual switch or remote control is wired into the circuit on the mains voltage side of the transformer; failure to observe this requirement may lead to damage of the panels.



SWITCHABLE FILM SPECIFICATIONS

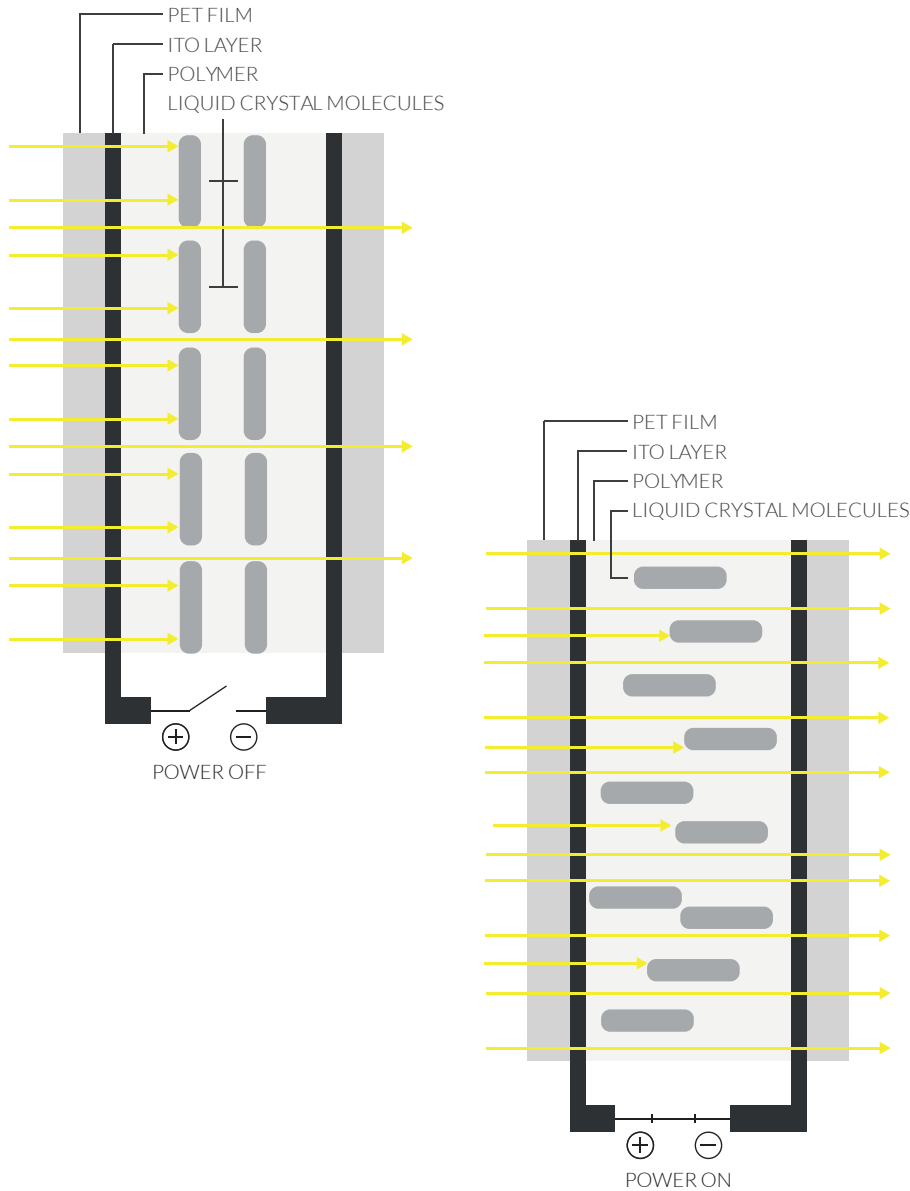

| | | | |
|--------------------|-----------------------|--------|--------------------------------|
| OPTICS | LIGHT TRANSMISSION | ON | >88% |
| | | OFF | >60% |
| | HAZE | ON | <3% |
| | | OFF | <95% |
| | UV BLOCK | ON/OFF | <98% |
| VIEWING ANGLE | ON | >160° | |
| ELECTRICAL | VOLTAGE | ON | AC 48 - 65V |
| | POWER CONSUMPTION | ON | < 5W per m ² |
| | FREQUENCY | ON | AC 48 - 65V |
| | CURRENT | ON | 0.1 amperes per m ² |
| | SWITCHING TIME | OFF>ON | 45ms |
| ENVIRONMENT | OPERATING TEMPERATURE | ON/OFF | -20°C to +70°C |
| DURABILITY | LIFETIME | | >80,000 hours |
| | TEST TIME | | > 2 millionswitches |
| | PEEL STRENGTH | | > 350 gf per inch |
| DIMENSIONS | MAXIMUM LENGTH | | 4 metres |
| | MAXIMUM WIDTH | | 1.5 metres |
| | THICKNESS | | 0.45mm |

TRANSFORMER SPECIFICATIONS

50W

| DESCRIPTION | SPECIFICATION |
|----------------------|--------------------------------------|
| DIMENSIONS | 165 x 120 x 60mm |
| PRI WIRE | 2 x 0.75mm ² Black UK pin |
| WEIGHT | 1.96kg |
| FULL LOADING POWER | 50W (MAX) |
| INPUT VOLTAGE | AC220V ± 10% |
| FREQUENCY | 50Hz / 60Hz |
| NO LOAD VOLTAGE | AC60 ± 2% |
| FULL LOADING CURRENT | 3.6A (MAX) |



200W

| DESCRIPTION | SPECIFICATION |
|----------------------|------------------------|
| DIMENSIONS | 195 x 125 x 80mm |
| PRI WIRE | 2 x 0.75sq. 0.9m Cable |
| WEIGHT | 3.5kg |
| FULL LOADING POWER | 200W (MAX) |
| INPUT VOLTAGE | AC220V ± 10% |
| FREQUENCY | 50Hz / 60Hz (45-60Hz) |
| NO LOAD VOLTAGE | AC60V ± 2% |
| FULL LOADING CURRENT | 3.6A (MAX) |



WIRING DIAGRAMS

Switchable Glass & Film Wiring Diagram

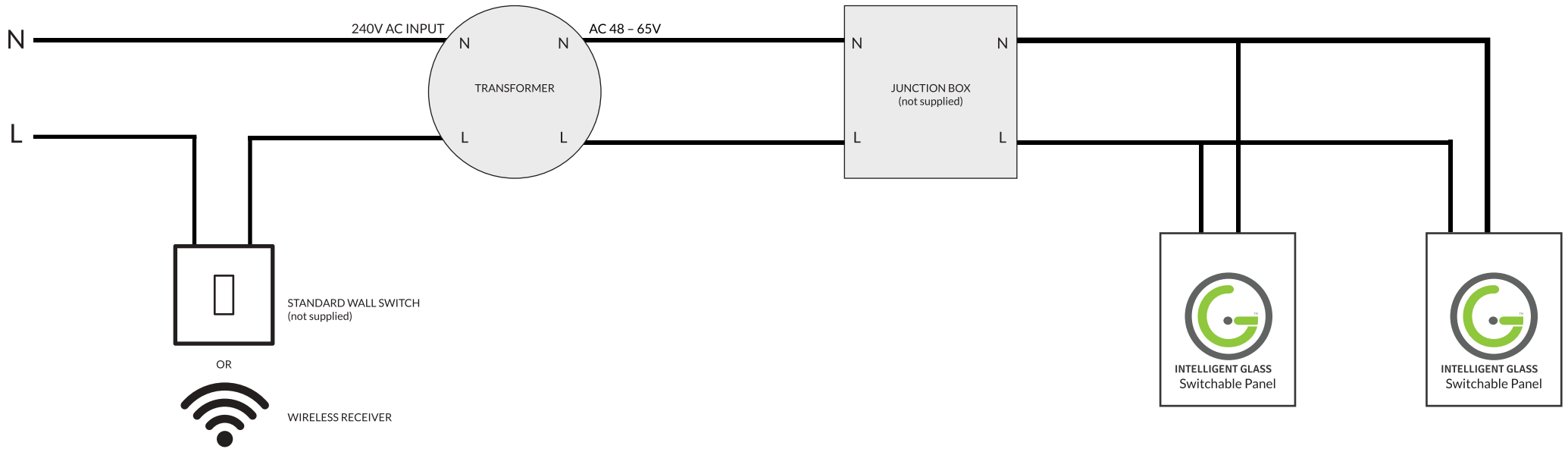

RF Receiver Wiring Diagram

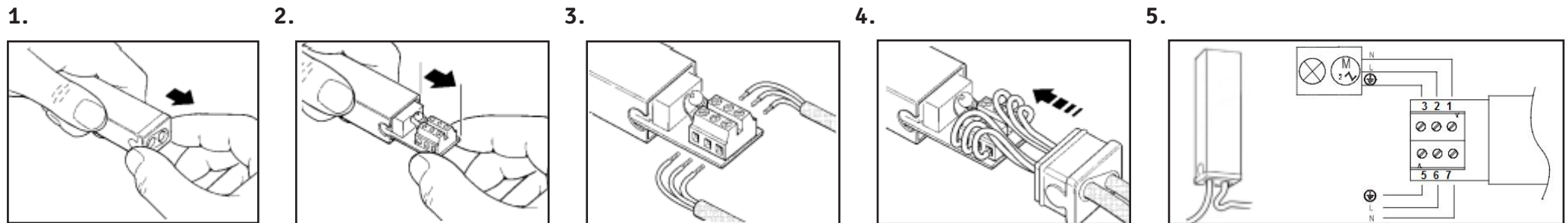

CLEANING & AFTERCARE

We recommend that Switchable Film should be cleaned with IPA wipes which are available for purchase from Intelligent Glass.

We do not recommend cleaning Switchable Film with water or cleaning liquids as this could damage the film if the electrical contacts or edges are exposed to moisture / chemicals.

We recommend that external windows are completely sealed to avoid moisture ingress.

Switchable Film is an electrical product and to ensure longevity, we recommend leaving the film off for up to 8 hours per day.

WARRANTY

Intelligent Glass warrants that Switchable Film products should be free from defects assuming normal use and correct installation for a period of 2 years from date of delivery. Defects include loss of switching where the electrical system has been wired correctly.

Haze: Switchable Film products are not as optically clear as standard glass. All Switchable technologies have some degree of haze and this is not deemed as a fault.

Switching Time: Whilst the transition time from frosted to clear is usually less than 1 second, the transition time from clear to fully frosted can vary depending upon ambient temperature, length of time the film has been switched clear and age of the product, such variability in transition is normal and not deemed as a fault.

Substrate Quality: It's important that the Glass or Acrylic the film is being applied to is of good condition. Any defects in the Glass or Acrylic may appear through the film.

Film Quality: There may be slight variations in the thickness of the liquid crystal over the surface area causing slight tint variation and is not deemed as a fault.

Tolerance: Switchable Film dimensions have a tolerance of +/- 2mm.

To activate the warranty, send clear images of the film being switched clear and frosted to warranty@intelligentglass.co.uk

Your warranty will be activated upon receipt of these images.

All sales are subject to Pro Display TM Ltd terms & conditions.

 intelligentglass.net

 Intelligent Glass

 @IntelligentGlas

 @IntelligentGlass

 Pro Display

 INTELLIGENT GLASS®

+44 (0)1226 361 306

hello@intelligentglass.net

intelligentglass.net

